

ООО «ТИ-СИСТЕМС» ИНЖИНИРИНГ И ПОСТАВКА ТЕХНОЛОГИЧЕСКОГО ОБОРУДОВАНИЯ  
Интернет: [www.tisys.ru](http://www.tisys.ru) [www.tisys.kz](http://www.tisys.kz) [www.tisys.by](http://www.tisys.by) [www.tesec.ru](http://www.tesec.ru) [www.ти-системс.рф](http://www.ти-системс.рф)  
Телефоны: +7 (495) 7774788, 7489626, (925) 5007155, 54, 65  
Эл. почта: [info@tisys.ru](mailto:info@tisys.ru) [info@tisys.kz](mailto:info@tisys.kz) [info@tisys.by](mailto:info@tisys.by)



# Peiyang Chemical

天津市天大北洋化工设备有限公司  
Peiyang Chemical Equipment Co.,Ltd



## The world's leading manufacturer on mass transfer equipment.

### Enterprise Introduction

Peiyang Chemical Equipment Co., Ltd.( referred to as PCC) is one of the largest manufacturer of packing & column internals. Through decades of engineering practice, PCC has developed a lot of intellectual property rights and patented technology with international standards, which are widely used in petrochemical, coal chemical, fine chemical, air separation, new materials, new energy, environmental protection, medicine, food and other fields, and has made remarkable achievements.

### Main fields

PCC focuses on the design & manufacture of distillation, absorption, extraction and other sets of mass transfer equipment. For existing and new separation device, PCC can provide professional technical services to improve the processing capacity, to heighten the quality and yield of separation, to reduce energy consumption and operating costs. There are more than 10,000 fractionating columns that used PCC's technology and products, which are involved in petrochemical, coal chemical, air separation, chemical and other fields.

### Honor & Certificates

PCC is located in Tianjin Industrial Park of Tianjin University of Jinghai economic development zone, in which has production and experimental base. PCC was awarded the National New Product Certificate, Second Prize of National Science and Technology Progress. PCC also passed the ISO 9001:2008, had the National Ⅰ class pressure vessel manufacturing qualification, gained ASME U stamp.

### Coop. & Dvpt.

In 2012, PCC became the member of FRI, which is the worlds leading distillation research organization. FRI is a non-profit organization, and its main function is to develop and exchange distillation technology. Its members include the world's top chemical giant.

### Market development

PCC products not only meet the domestic needs of customers, such as becoming the long-term supplier and technology partner of large enterprises, like the PetroChina, Sinopec, MCC, CNASPC, Hangyang, Kaifeng air separation and Kaiyuan air separation, but also are exported to France, Italy, Japan, the United States and other countries around the world.

Design sketch of PCC new production base.



## Professional R & D and manufacturing

We offer the full support and services from feasibility studies - process development - product design & manufacturing - construction - site guidance

### R & D

PCC attaches great importance to technology development and reserve, and has invested in the construction of two international advanced distillation laboratories. One laboratory is for mass transfer equipment, equipped with 80mm hot membrane & 80mm old membrane experimental device, provides a reliable guarantee for R & D, and design. One laboratory, which is pilot device that contains three  $\Phi 50$  mm hot membrane packed tower, can complete the polysilicon separation, high difficult purification study of heterogeneous experimental, meanwhile can achieve research and development tasks of reactive distillation and other multiple objectives.

In 2014, PCC plans to build a higher level of rectification laboratory, so that it can complete numerous operating units of the simulation and pilot from the distillation to reaction. PCC has a 12\*12m hydraulic experimental platform, which can perform hydraulic test for the liquid distributor below 2m diameter to ensure performance of liquid distributor for large tower.

### Skid mounted

In the past few years, PCC strengthened its R&D about skid mounted products, and set up a Skid Mounted Products Department to develop the modular chemical plants and marine skid mounted equipment. At present, we have accumulated rich expertise and experience in engineering after designed a lot of skid mounted equipment for domestic and foreign customers.

### Design and service

We can provide full service for customers, including:

- Process simulation
- CFD study
- Feasibility study
- Basic engineering
- Detailed engineering
- Equipment design
- Installation at site
- Commissioning
- Start-up assistance
- Trouble shooting

### Main products

- Engineering service
- Structured/Random packing
- Column internals
- Column & vessel
- The whole set of skid mounted

### Manufacture

PCC has over 400 sets of professional equipment. Most of these packing production equipment were developed by PCC, and they have domestic and international advanced level.

Professional distillation laboratory



Hydraulics experimental platform-12x12m



## PCC - Mass Transfer Technology

### The world's leading manufacturer on mass transfer equipment.

For more than 50 years we have been serving the Process Industry, delivering innovative yet reliable solutions. From gas-liquid separation at the well-head to separation of vitamins, from petroleum refining to power generation, our products and technologies are employed for varied and demanding applications. There are more than 10,000 fractionating columns that used PCC's technology and products, which involved in petrochemical, coal chemical, air separation, chemical and other fields.



### ■ Natural Gas

- Natural Gas Scrubbing
- Natural Gas Drying
- Gas Sweetening
- Gas Fractionation
- Condensate Stabilizer
- Gas/Liquid Separation
- Liquid/Liquid Separation

### ■ Refinery

- Crude Oil Distillation
- FCC Vacuum Towers
- Lube Oil Distillation
- Coking and Visbreaking
- Hydrotreating
- Fractional Distillation

### ■ Petrochemical

- Acetic Acid
- Ammonia
- Aromatics Ethylene Oxide and Derivatives
- Olefins
- Phenol and Derivatives
- Styrene
- Diisocyanates (MDI/TDI)

## Main Achievement

1. PCC is China's largest manufacturer of air separation distillation column internals and packing, completed thousands of sets of equipment, and the maximum reached 80,000m<sup>3</sup>/h.
2. We are pioneer in application of high effective structured packing in the field of polysilicon manufacture. We are largest single set of silicon purification plant (6,000 ton/year) designer and manufacturer on column equipment.
3. PCC is the largest methanol distillation system (600,000 tons/year) designer and manufacturer.
4. PCC is the largest CO<sub>2</sub> capturing and purification distillation system designer and manufacturer (200,000 tons/year CO<sub>2</sub> refinery).



## ■ Chemicals

- Alcohols
- Biofuels and Biochemicals
- Caprolactam
- Terephthalic Acid
- Purified Terephthalic Acid
- Oleochemicals
- Flavor and Fragrances
- Vitamins







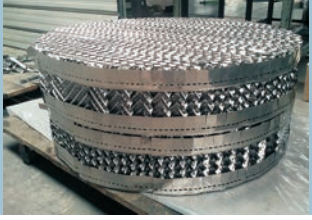

## ■ Power Generation

- Carbon Capture & Storage
- Waste Power Generation
- Heavy Water Upgrading
- DeNO Plants
- Flue Gas Treatment





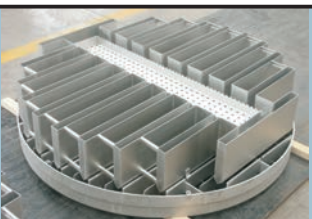

## ■ Other Industries

- Coal chemical industry
- Air Separation
- Silanes
- Fertilizers
- Many more...

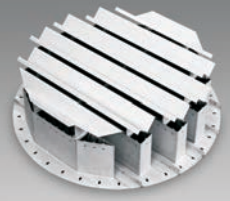
## Main Products

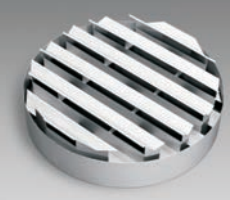
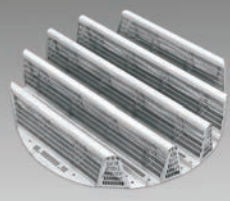
<p><b>PY-M Structured Packing</b></p>	<p>Highly effective corrugated plate packing has many different surface treatment methods, which has wide application.</p>	
<p><b>PY-W Structured Packing</b></p>	<p>Metal wire gauze corrugated packing is applied to column which needs high theoretical plate, which can lower column height a lot.</p>	
<p><b>PY-K Structured Packing</b></p>	<p>Mono type air separation packing, with the largest diameter <math>\Phi 500\text{mm}</math>, is easily installed. It has high separate efficiency, also saves energy and protects environment.</p>	
<p><b>PY-Grid Structured Packing</b></p>	<p>Grid packing is easy to revamp, mainly applied to oil and gas separation unit, and quench tower.</p>	
<p><b>Pall Ring</b></p>	<p>Pall ring can improve gas and liquid distribution, with large process capacity and wide application.</p>	
<p><b>Super Ring</b></p>	<p>New type cascade ring can be used in reabsorb tower, amine absorber and aromatics extraction of lubricating oil.</p>	
<p><b>Channel Liquid Distributor</b></p>	<p>This widely used liquid distributor has well-distributed and easily installation character.</p>	
<p><b>Pipe Liquid Distributor</b></p>	<p>Pipe distributor has simple structure, free section for liquid flowing, lower resistance, which is mainly applied to packing column with liquid load bellow secondary.</p>	

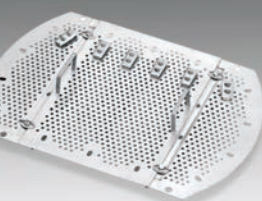
## Main Products

<p><b>Liquid-gas Distributor</b></p>	<p>New type through-pan liquid distributor has small space occupying, anti-clogging, which has excellent character of leakage prevention and easy installation.</p>	
<p><b>Gas Distributor</b></p>	<p>Dual vane gas distributor has simple structure. When applied to column with large diameters, it can evenly distribute gas.</p>	
<p><b>Collector and Distributor</b></p>	<p>It can collect liquid and distribute liquid, also has small occupation with high transfer efficiency.</p>	
<p><b>Hump Support</b></p>	<p>Various bed limiters and packing supports can effectively fix packing position, which can meet request of distributors and unit.</p>	
<p><b>Demister</b></p>	<p>Various demisters can effectively eliminate entrainment, which have excellent characters of easily installation and high operation flexibility.</p>	
<p><b>High Efficiency Tray</b></p>	<p>SGTV and many know-how matched for high effective tray, which can effectively reduce blind spot of trays, and increase process capacity.</p>	
<p><b>Column</b></p>	<p>With design and manufacture licence of pressure vessel, we can design and manufacture many kinds of columns.</p>	
<p><b>Heat Exchanger</b></p>	<p>PCC has ASME U stamp certification, and can design and produce various types of heat exchangers, extraction, reaction and crystallization equipment.</p>	

## The High Level of Complete Sets of Equipment

The combination of eight key elements is: Process Design, Equipment Design, Automatic Control Design, Manufacture, Engineering Design, Installation, Commissioning & Training. After-sales Service, providing the company with the ability of undertaking turnkey projects independently.

### Co<sub>2</sub> Plant

We will combine adsorption and distillation process to make specific design according to exhaust different fuels (including combustion exhaust, fermentation exhaust, chemical synthesis exhaust gas, petroleum and petrochemical gas, etc.).

Greatly reducing labor costs and error rates by full automatic control system of DCS monitor, realizing unattended;

Using nobody-duty unique dealkylation process, simplifying the process and equipment constitute, reduce equipment one-time investment, consumption and operation difficulty; Purity grad can be reached in accordance with the needs of electronic grade, food grade and industrial grade; Monitoring key points of production operations, high multiple energy-saving design, low running costs.



CO<sub>2</sub> Recoverd & Purified Plant (200,000 ton/y)

### Solvent Recovery Plant

Designing the solvent recovery system in accordance with the single function or multi-function operation;

Realizing processing various solvent streams in batch, planned and continuous production;

The distillation process adopts the combination of optimizing technologies about distillation, liquid - liquid extraction, absorption, thin film evaporation to ensure that you can achieve lower life-cycle costs. Provide the cost-effective solvent recovery system for you, and bring you enormous economic and environmental benefits.

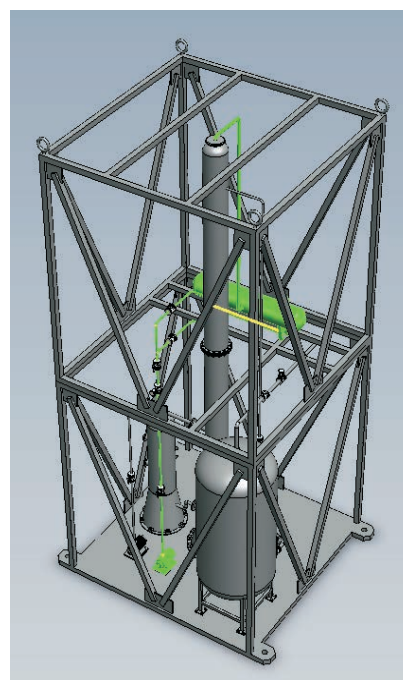

THF Solvent Recovery Plant



**We work with you to deliver optimum solutions.**

Our design team will combine your needs and our know-how and use cutting-edge design tools. We help you get the technically and economically optimal solution. We will do our utmost to make you gain more!

---

## Air Separation Plant

The medium-sized & large-scale air separation plants, which are designed and manufactured by PCC, adopt the purification system of activated alumina - molecular sieve double-decker structure to prolong the durability of molecular sieve.

By using packed tower for the upper tower of Fractionator tower, reduce the upper and lower towers operating pressure, then increase product extraction rate, and reduce the energy consumption; Use entire distillation technology for argon production system, which has good equipment safety, and can reduce investment and operating costs. Adopt full low-pressure procedure for small air separation plant, molecular sieve adsorption at room temperature, turbine expansion refrigeration; By using multilayer wrapping instead of perlite for cryogenic liquid storage equipment, eliminate the hidden danger of perlite sinking.

---

## LNG Gasification Plant

Design the units of filtration, removing heavy hydrocarbons, acid gas desorption, dehydration, demercuration and other units according to the customer's gas source conditions;

Variety of alternative liquefaction processes: natural gas throttling, nitrogen expansion, azoxy methane expansion, natural gas expansion, cascade refrigeration cycle, MRC refrigeration, propane pre-cooled + MRC refrigeration;

LNG plant process consists of pretreatment (purification), liquefaction, storage, loading and auxiliary systems, and the main process includes gas purification and liquefaction processes for raw material.



Small-scale Air-separation Plant



LNG gasification with skid

## Qualification and Honor

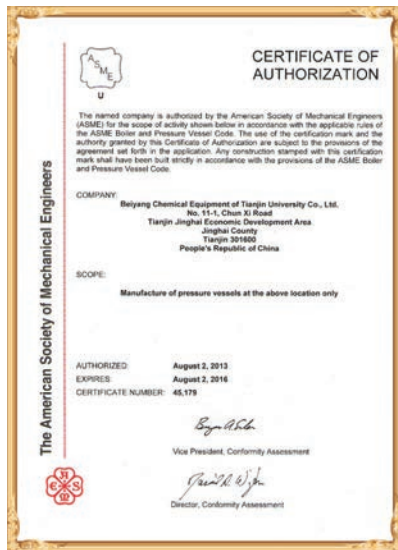

PCC has acquired the ASME U stamp & the certificate.



## ASME U Stamp



## Certificate

Throuh systematic and effective Quality,Safety, and Environmen system, PCC creates sustainable future driving force of growth.



ISO9001: 2008



National Scientific Progress Award



Pressure vessel certificate



Exhibition Silver



National High-tech Enterprise Certificate



ASME U/NB Certificate



Tier one suppliers of CNPC



Air Packing Certificate



Oil refining Certificate



Tier One Suppliers of SINOPEC

## Study on the Tray



图3 凯宁公司的复合孔微型阀

Crenate valves genuinely divide the gas stream out of one single valve into multiple small gas stream to increase the gas surface area.

Kaining has improved and optimized the main elements of the valve plate, bubbling promote and downcomer. And the high efficiency tray with compounded miniature valve, which developed by PCC, has high vapor-liquid flux & mass transfer efficiency.

PCC takes advantage of Kaining's advanced tray process to transform traditional plate column and gains satisfactory results from customers.

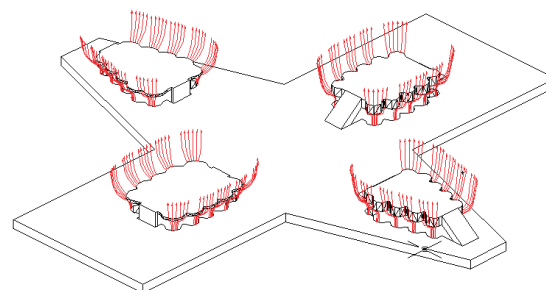
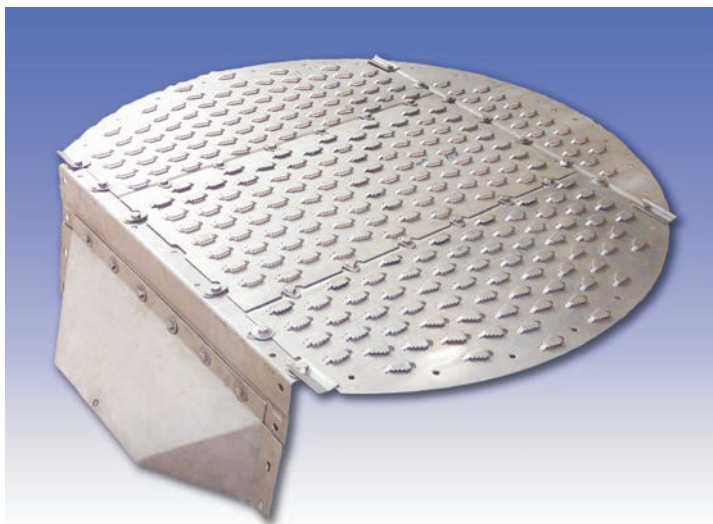
The high efficiency tray with compounded miniature valve will keep contributing to the aspects of improving product quality, increasing yield, reducing the energy consumption and environmental protection.

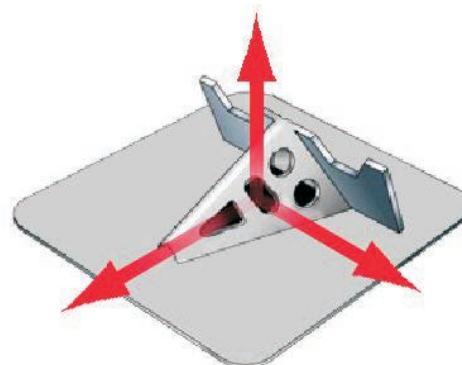

Triangular bubbling promoters instantly blend the clear liquid out of downcomer with gas into froth.

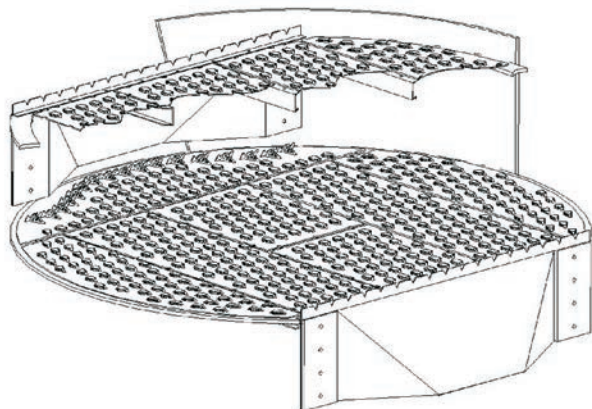

Crenate valves, swept-back downcomer and triangular bubbling promoters use together increase the gas-liquid exchange area, improve the efficiency of trays.

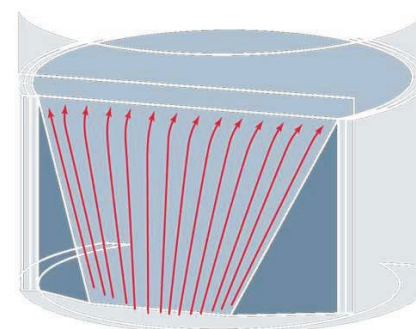

Swept-back downcomer increases the bubbling area and optimize the liquid flow on the tray.

## Design

PCC has a professional engineering team can meet the user's needs for professional process design. Because of their strong design capabilities and a wealth of engineering experience, PCC design often allows users have higher productivity and lower operating costs.

### Engineering Services

- Process simulation
- Feasibility study
- Detailed engineering
- Installation at site
- Start-up assistance
- CFD study
- Basic engineering
- Equipment design
- Commissioning
- Troubleshooting

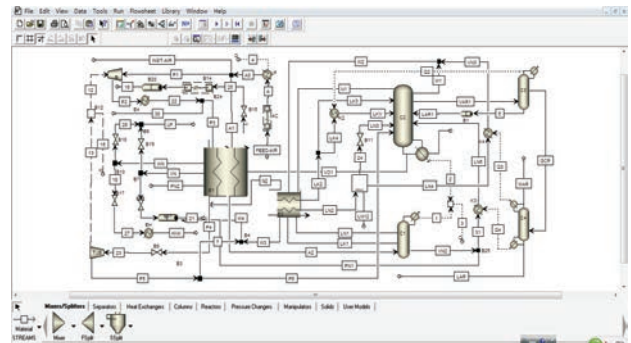

Design by ASPEN

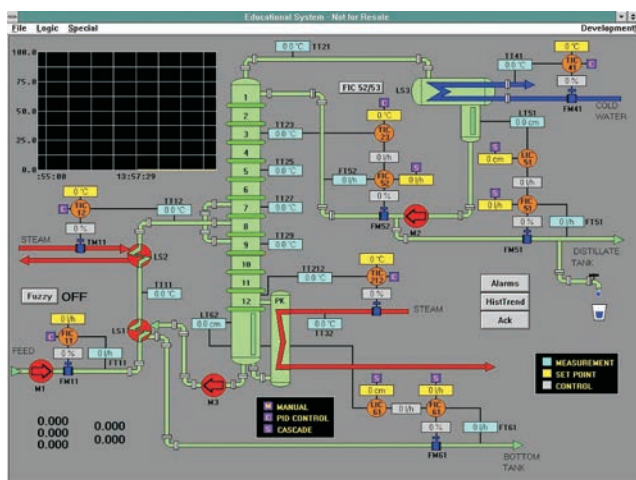

Engineering Design

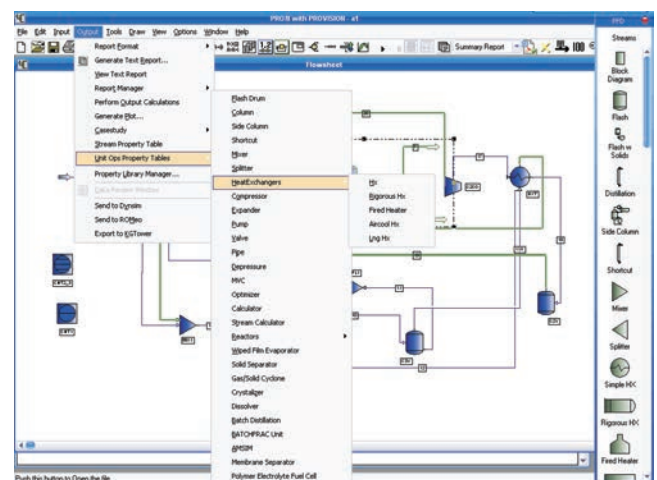

Process Simulation and Calculation

## Processing Simulation

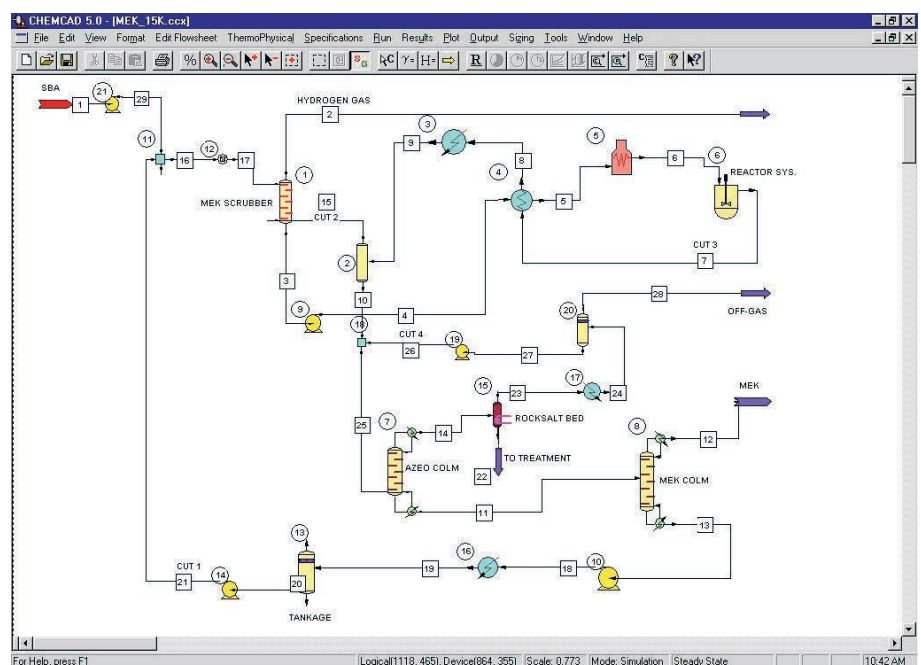

## Design

### Process design about pressure vessel

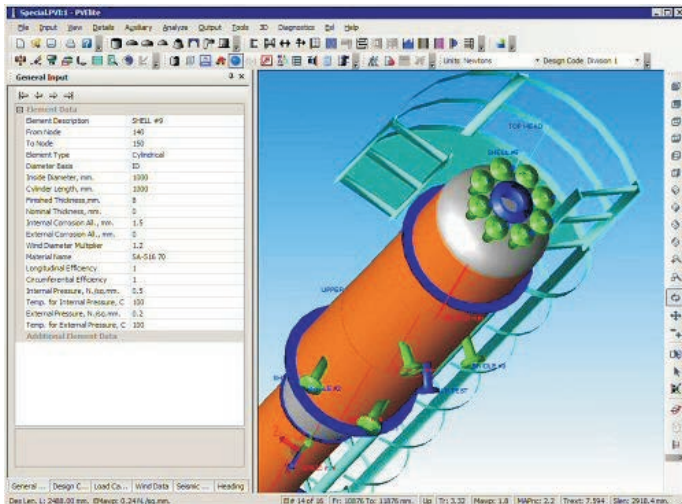

Design of Distillation Tower

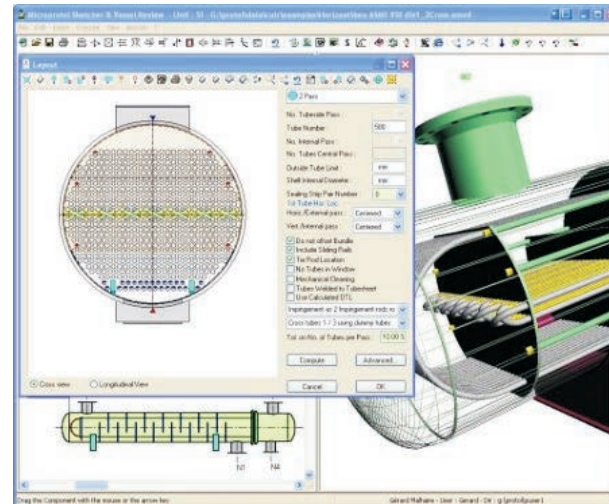

Design of Heat Exchanger

## Distillation Laboratory



▲ DCS operating platform of distillation laboratory

◀ PCC can conduct cold membrane and hot membrane test for column internals, pilot plant design and implementation, and miniaturization production etc.

## Inspection



① **Handheld Spectrum Material Measuring Instrument**

② **High Level of Precision Measuring Instrument**



### Hydraulic Test

The company has a program-controlled large-scale hydraulic platform, can be up to 12 meters in diameter distribution hydraulics experiments.



### Physical & Chemical Testing

We can test the performance and chemical composition of material in the laboratory, which ensures the quality and reliability of raw materials.

## Product Site

PCC has 325 sets professional equipment. In most of these packing production equipment was developed by PCC, it has the leading domestic and international advanced level.

Due to technical level and manufacture equipment limits, almost companies in the world only can produce the air-separation packing with the biggest diameter about 3 meters for mono type. After the untiring efforts and innovation, PCC conquered the technical barrier, and designed & manufactured the whole production line for the mono type packing in 2005. From that on, PCC had manufactured lots of big diameter air-separation packing, and the largest column diameter even up to 5.5 meters.



① Automatic production line for air separation packing

② Punching & welding distributor

③ Welding pressure vessel

④ Water cooling tower was leaving the workshop



## Main Achievement

### 1. Coal chemical projects :

NO.	Project	Client	Diameter
1	600000 t/y MTO project	Shandong Hengtong Chemical Group	Φ1000/Φ900-1600/Φ700
2	Shenhua Ningxia Coal Industry Group olefin syngas to Propylene project	HQC	Φ800/Φ1200/Φ1700/ Φ1800/Φ2800
3	200000 t/y Methanol project	Shandong Yankuang internationalCoking Co	Φ800/Φ2200/Φ2800
4	200000 t/y Methanol supporting project	Shaanxi Shenmu Chemical Industrial Co.	
5	150000 t/year Methanol rectification column	Jiutai Energy	Φ1400~Φ1800
6	Methanol rectification column, stripping column	Yankuang Chemical Co	Φ600/Φ1800/Φ2200/Φ2800
7	Methanol equipment	Gansu Liuhua Jituan	Φ800/Φ1400/Φ1600
8	Methanol equipment	Yankuang Chemical Co	
9	100000 t/year Methanol rectification equipment	Heilongjiang Haolianghe Huafeichang	Φ1200/Φ1600/Φ1900/Φ600
10	Methanol recover	Northeast Pharmaceutical Group Co.	Φ600/Φ1600/Φ2600/Φ2800
11	300000 t/year Methanol equipment Methanol rectification column	Qinghai oilfield Golmud refinery	Φ2600/Φ3200/Φ900
12	500000 t/year Methanol equipment rectification	Yankuang Group Co.	Φ2900/Φ3400/Φ4100/Φ1400
13	600000 t/year Methanol equipment	Yanzhou coal industry Yulin Co.	Φ4100/Φ4200/Φ5000/Φ1400
14	200000 t/year Methanol equipment	Baofeng Energy	Φ2200/Φ2800/Φ800
15	Hebi coal power 600000 t/year Methanol rectification equipment	Henan Runlong trade company	Φ3100/Φ3500/Φ4200/ Φ1200/Φ600
16	150000 t/year Methanolrectification column	Jiutai Energy	
17	240000 t/year Methanol rectification system and desulfuration, decarburization system column internal	Shandong Yankuang international Coking Co.	
18	180000 t/year natural gas Methanol rectification system	Inner Mongolia Sulige	
19	350000 t/year Methanol rectification system increase production reconstruction	Shanghai coking	
20	250000 t/year Methanol rectification equipment	Yankuang coking	
21	300000 t/year Methanol rectification equipment	Qinghai Geermu Oil Refining factory	
22	500000 t/year Methanol rectification system	Shandong Yankuang	
23	Tongzi Coal chemical Industry Phase Oneproject 300000 t/y Methanol rectification equipment	Guizhou Jinchi chemical	
24	240000 t/year coke-oven gas Methanol rectification system	Ningxia Baofeng	
25	600000 t/year Methanol, 0.5 billion m <sup>3</sup> /year LNG project MDEA purification system project	FuGuXian hengyuan coal tar electrochemical Co.	Φ3600/Φ4000



## Main Achievement

### 2. Oil refining projects :

NO.	Project	Client	Diameter
1	8 million tons/year vacuum tower	Sinopec Shanghai Gaoqiao company	Φ10200、Φ8800、Φ8400
2	Qilu Petrochemical project	NERCDT	Φ9200
3	Vacuum tower reconstruction	Shengli Oilfield heavy oil factory	Φ2400/Φ3200
4	Vacuum tower reconstruction	PetroChina Karamay Petrochemical Co	Φ1200/Φ3400/Φ5000
5	Catalytic fractionating column	PetroChina Fushun petrochemical	Φ4200
6	Dagangvacuum tower	Tianjin Tiandatianjiu Polytron Technologies Inc	Φ5200/Φ7400/Φ8200
7	ZRCC II set atmospheric and vacuum distillation equipment expanding capacity reconstruction	NERCDT	Φ3600/Φ5800/Φ4200/Φ6400
8	Distillation vacuum tower top cycle reconstruction	PetroChina Jinxi Petrochemical Company	Φ3400/Φ5000/Φ5400/Φ6400
9	1600000 tons/year atmospheric and vacuum distillation equipment expanding capacity reconstruction	Jingmen Petrochemical	Φ1400~Φ6400
10	Hainan project	NERCDT	Φ4400/Φ7800
11	2500000 tons/year atmospheric and vacuum distillation equipment	Karamay Petrochemical Co.	Φ1600/Φ2000/Φ3600/Φ6400
12	1600000 tons/year hydrogenation cracking equipment	Liaoyang Petrochemical Co.	Φ3800
13	North China Petroleum project	NERCDT	Φ1400/Φ1000/Φ3200/ Φ1200/Φ800
14	Jinzhou Petrochemicalproject	NERCDT	Φ1200/Φ1400/Φ1000/Φ800/ Φ3200/Φ3800/Φ2000
15	Chang III equipment vacuum tower reconstruction project	Shandong Binhuabinyang Chemical & Gas company	Φ2800/Φ4200
16	Fujian Oil Refiningethylene project800000 tons/year ethylene,500000 tons/year petrol hydrogenation equipment	Sinopec Engineering Inc.	Φ2600
17	Vacuum tower column internal	Sinopec Jingmen Co.	Φ6400
18	Vacuum tower	Sinopec Jingmen Co.	Φ6400
19	Vacuum tower reconstruction	Jingmen Petrochemical Co.	Φ6400/Φ4200
20	ethylene equipment reconstruction	Sinopec Qilu company	Φ9200
21	ethylene quench tower	Sinopec Yangzi Petrochemical companu	Φ1600/Φ5000/Φ6600
22	Fujian Oil Refiningethylene project800000 tons/year ethylene,500000 tons/year petrol hydrogenation equipment	Sinopec Engineering Inc.	Φ3000/Φ5400/Φ2800
23	Fujian Oil Refiningethylene project	Fujian Refining & Petrochemical Company	Φ3600/Φ5000
24	ethylene project PO/SM equipment	Petrochemical Zhenhai branch	Φ6800/Φ10000/Φ3500/Φ3350/ Φ2900/Φ2600/Φ1700
25	1000000 tons/year ethylene and supporting project	Petrochemical Tianjin branch	Φ3000

## Main Achievement

### 3. Air separation projects :

NO.	Project	Scale ( m <sup>3</sup> /h)	Client
1	Shenhua Ningmei project	6*100000	Hangyang Limited
2	Qitou fangchenggang project	80000	Hangyang Limited
3	Shenhua project	2*60000	Hangyang Limited
4	China coal Shaanxi project	60000	Hangyang Limited
5	Zhongyuan Dahua project	52000	Hangyang Limited
6	PetrochemicalHubei project	48000	Hangyang Limited
7	PetrochemicalAnqing project	48000	Hangyang Limited
8	Yima project	40000	Kaifeng Air Separation company
9	Qitou fangchenggang project	35000	Hangyang Limited
10	Wuxi zhaoyuan project	30000	Henan Kaiyuan Air Separation Group
11	Yima chemistry project	20000	Sichuan Air Separation Group
12	Yingde project	16000	Hangyang Limited
13	Baigong project	15000	ZhongliAir Separation Co.
14	Ukraine project	10000	Hangyang Limited
15	Messer project	8500	Sichuan Air Separation Group
16	Daqing project	8000	Hangyang Limited
17	Turkey project	7500	Henan Kaiyuan Air Separation Group
18	Hongda /Jiujiang project	7000	Henan Kaiyuan Air Separation Group
19	Suopu project	6000	Hangyang Limited
20	Kazakhstan project	5000	Hangyang Limited
21	Jinguang project	4500	Sichuan Air Separation Group
22	UAE project	4000	Kaifeng Air Separation company
23	Foshan Messer project	3000	Hangyang Limited
24	Taiwan Lianhua project	2000	Sichuan Air Separation Group
25	Rumania project	1500	Hangyang Limited

## Main Achievement

### 4. Polysilicon & complete set project projects :

NO.	Project	Client	Diameter
1	L42191 Air Separation Plant	SIAD Macchine Impianti Trading Co., Ltd.	Italy Φ1400/Φ2000
2	Air Products CEC Project	Air Products (USA)	Φ5000/Φ5200/Φ5800/5700×5700
3	Scrubber system	MAADANIYAH	Saudi Arabia 25000/45000CMH
4	A108 Extraction Column	BONTOUX SA	France Φ323.9/Φ400/Φ700/Φ1500/Φ1600
5	Pyridine Project	Nanjing Huazhou Pharmaceutical Co., Ltd	Φ800/Φ1000
6	Aluminium Ethide 1500 Tons/Year	Zhejiang Fred Chemical Co.,LTD	Φ1600
7	Solvent Recovery and Energy-saving Project	Zhejiang Xin'an Chemical Industrial Group Co., Ltd	Φ400/Φ1600
8	Fluorine Cyanide Methyl Pyridine Project	Nanjing First Agricultural Chemical Group	Φ1700/Φ2000/Φ900/Φ1800/Φ600
9	Glyphosate Project	Suqian Zhenxing Chemical Co.,LTD	Φ800/Φ600
10	benzyl chloride project	Jiangsu Jinqiao salt group lihai chemical	80,000 ton/y
11	20000 tons formic acid project	Guizhou Kaiyang Xinqian Chemical Co.	Φ600/Φ1000/Φ1600/Φ1800
12	Pyridine project	Chongqing Huage Biochemical Co.	Φ1000/Φ400
13	PTA project MA hydrolysis unit	Zhengjiang Yisheng Petrochemical Co.	Φ1500/Φ1000/Φ600/Φ800
14	Acetone cyanohydrin project	Heilongjiang Zhongmeng Chemical	Φ600/Φ1200/Φ1600
15	10 thousand tons of HFP two phase of the project	Shandong Dongyue Polymer materials	Φ350~Φ1200
16	Glyphosate project	Nanjing Red Sun Co.,Ltd	Φ1200/Φ2000/Φ2400
17	Normal propyl alcohol distillation	Shandong Zibo Nuoa Chemical	Φ1200/Φ1500/Φ2000/Φ1800/Φ2500/Φ2200
18	Trichlorosilane rectification equipment	Nanhe Huayang Silicon Co.	Φ1000
19	2*6000 tons/year polysilicon and supporting industrial building project	TBEA Xinjiang Silicon Industry Co.	Φ3100/Φ2300/Φ3600/Φ1500
20	Luoyang 2000t/apolysilicon	China ENFI Engineering Co.	Φ2400/Φ2600/Φ2800
21	Luoyang 2000t/apolysilicon expansion	China ENFI Engineering Co.	Φ900/Φ2000/Φ2400/Φ2600/Φ2800
22	Polysilicon rectification purification project	Dunan Photovoltaic Technology Co.	Φ1600/Φ2200/Φ2700/Φ2800/Φ2900/Φ1900/Φ1800/Φ1200
23	Polysilicon project	Sichuan Yongiang Polysilicon Co.	Φ1500/Φ1600/Φ4000/Φ800
24	Annual output 250MW polysilicon and supporting project	XinjiangDaqo New Energy Co	Φ800/Φ1000/Φ1400/Φ1500/Φ1800/Φ2000/Φ2200/Φ2400/Φ2500/Φ2600/Φ2800/Φ3000/Φ3100/Φ1900
25	6000T apolysilicon technically improvement project	Yichang Nanbo silicon materials Co.	Φ2000/Φ2800